

Manuel d'installation

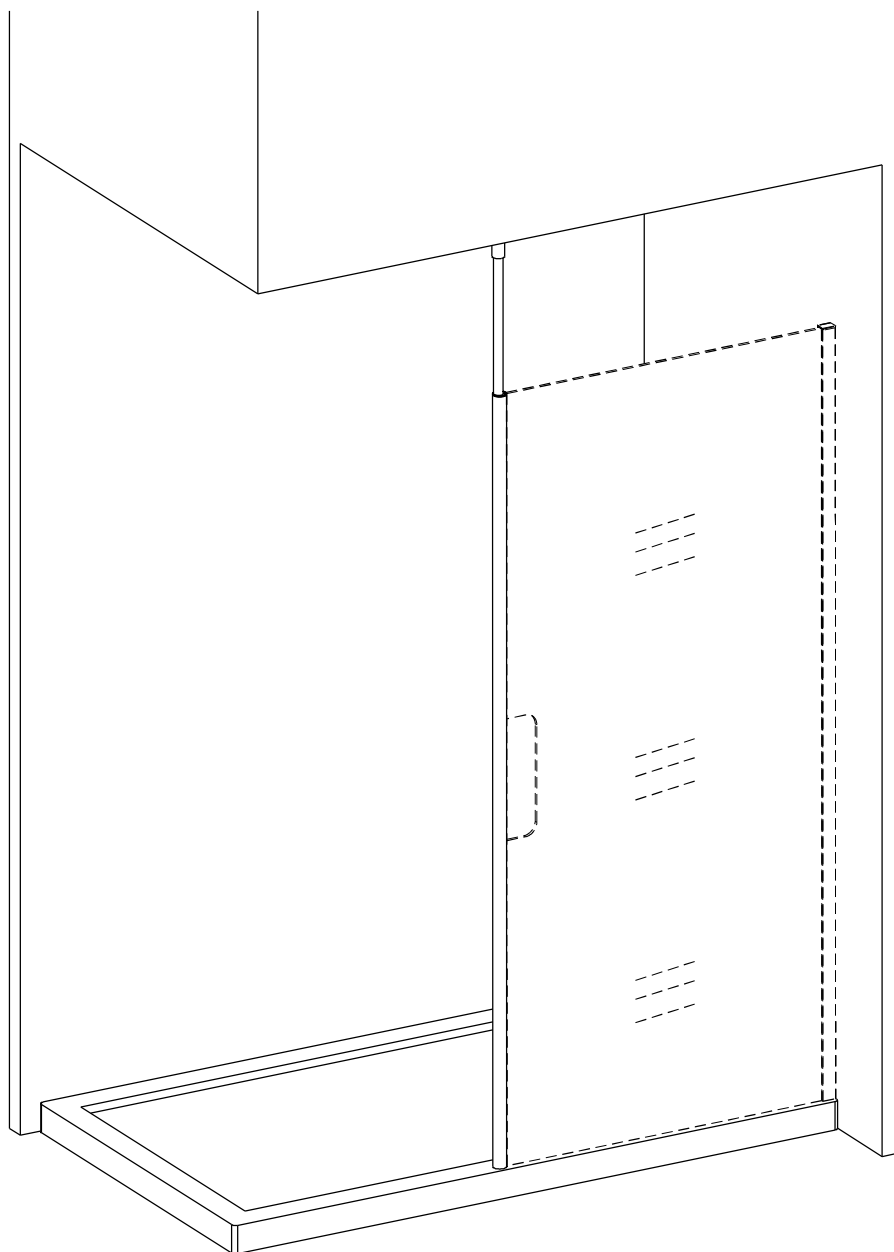

Outils nécessaires

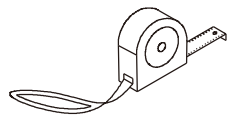

mètre ruban

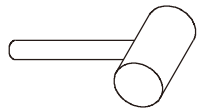

marteau en caoutchouc

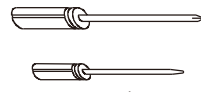

tournevis à tête plate & à lame

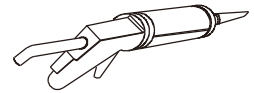

pistolet à silicone



niveau à bulle



2.5mm

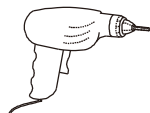

perceuse



crayon

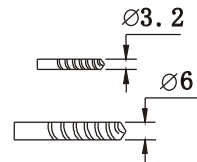

foret

Liste d'emballage

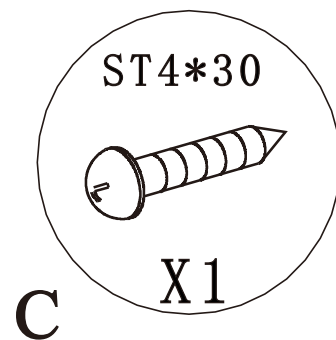
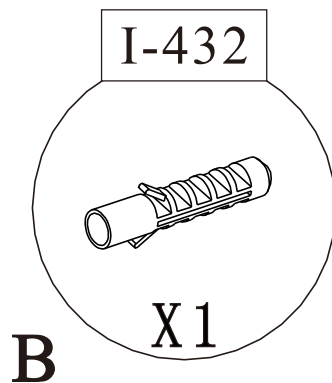
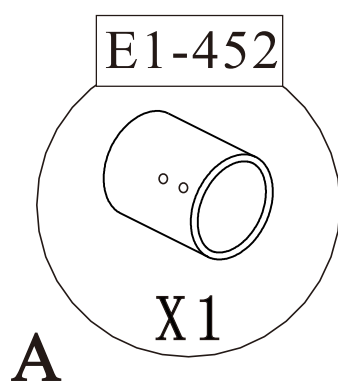

Le diagramme schématique du produit

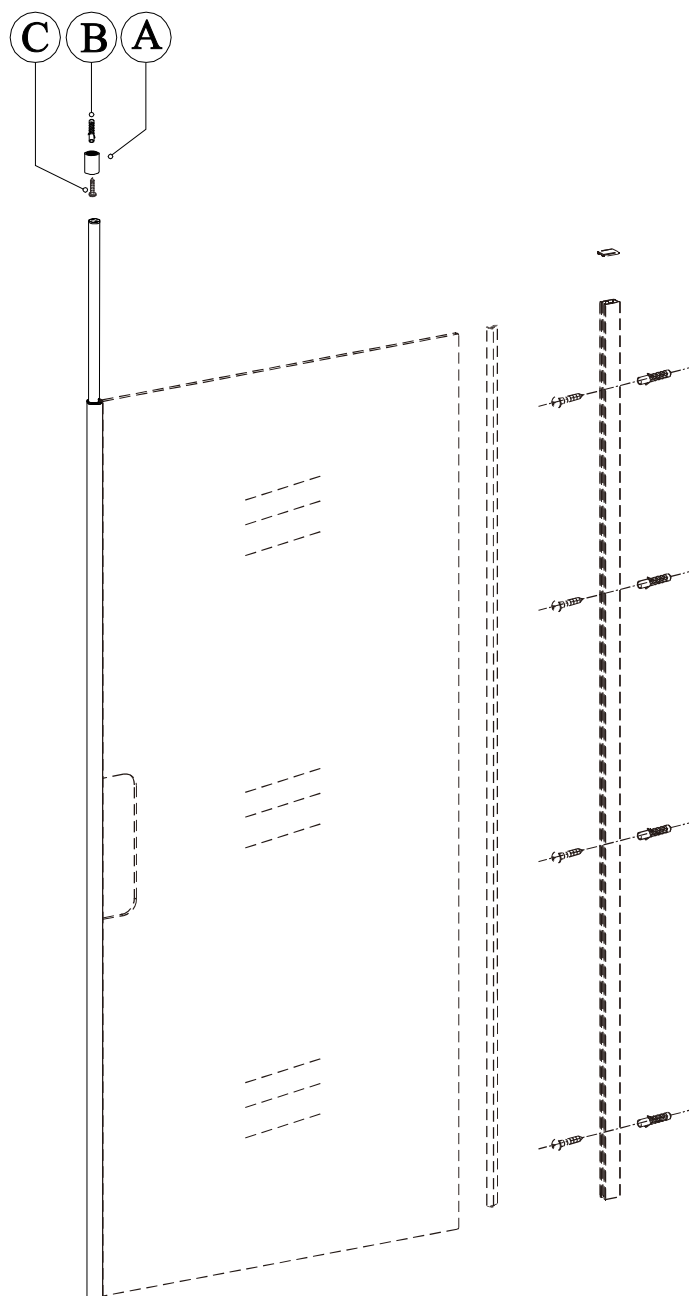

1

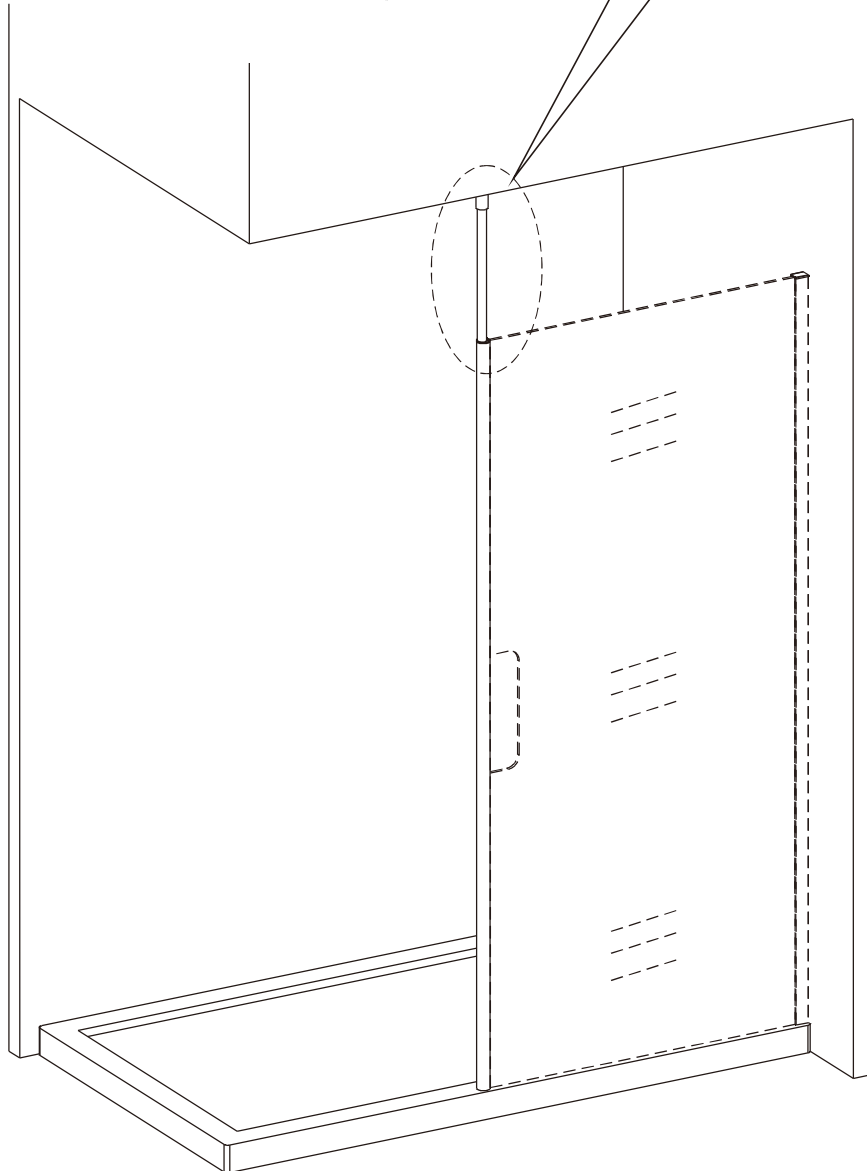
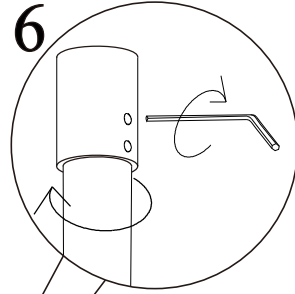
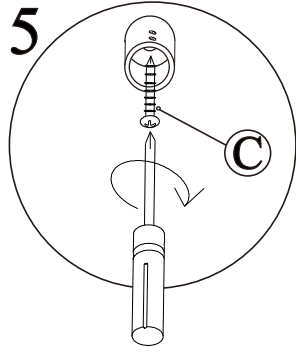
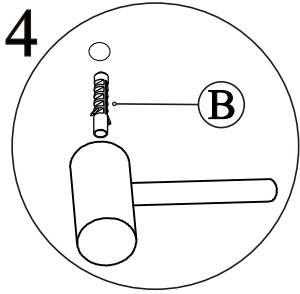
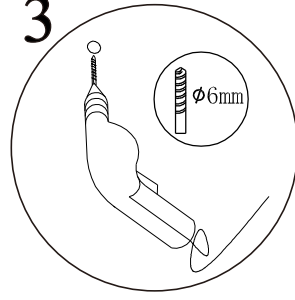
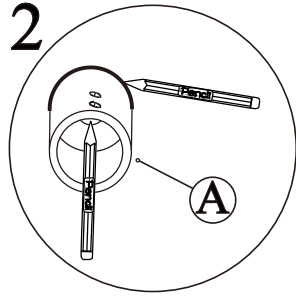
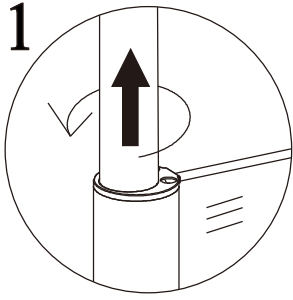

(3)

2

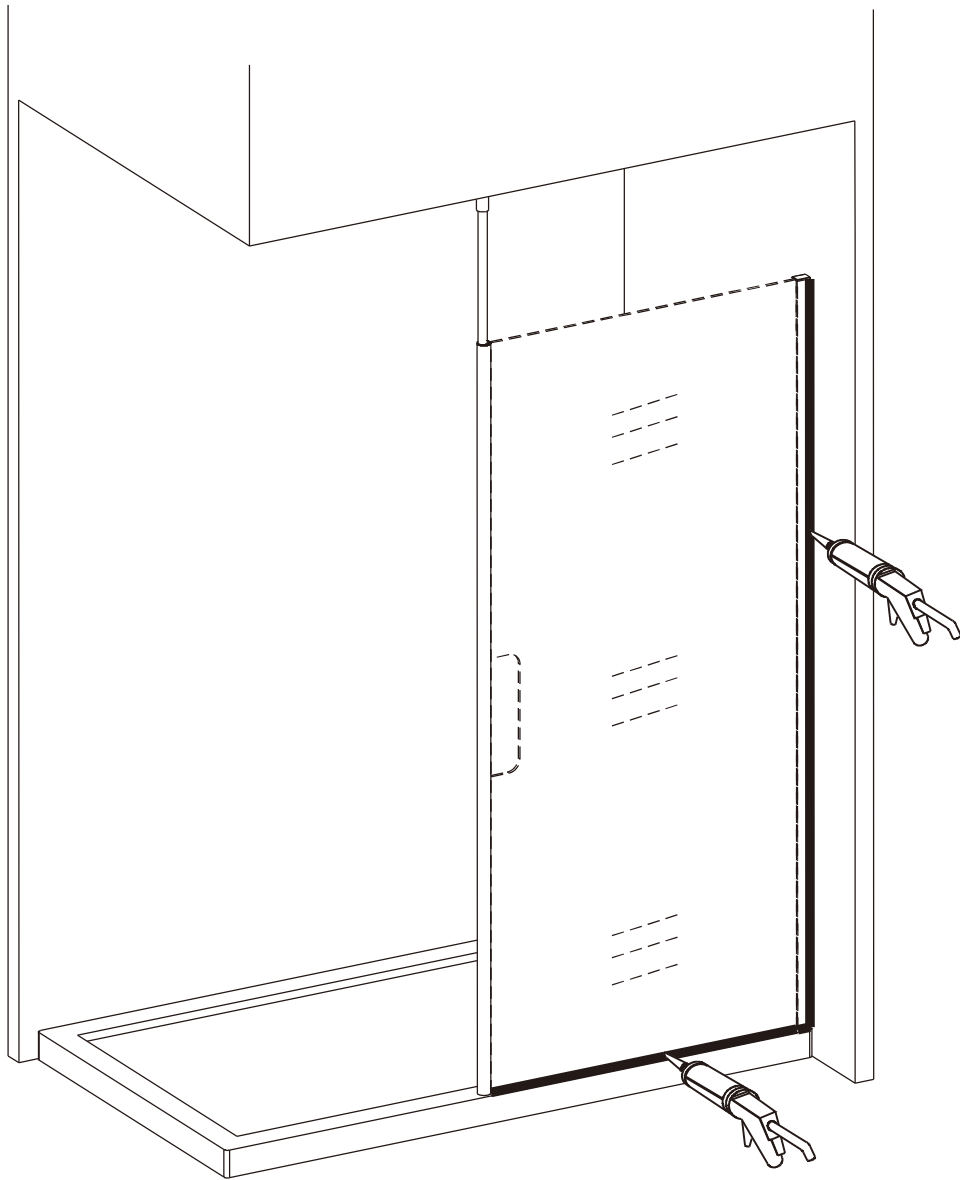

(4)

Attention

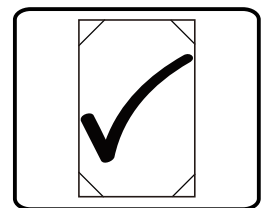
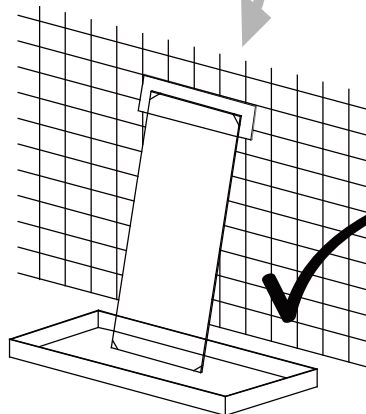
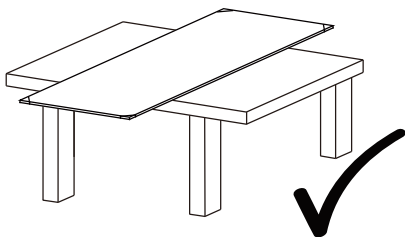
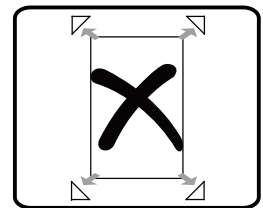
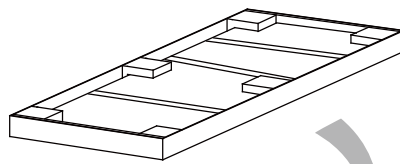
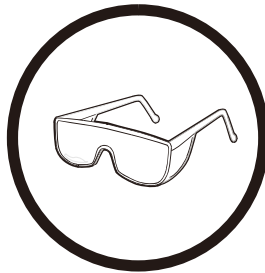
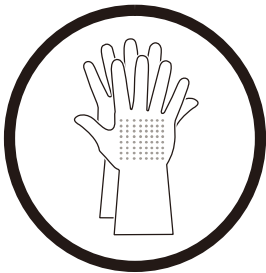
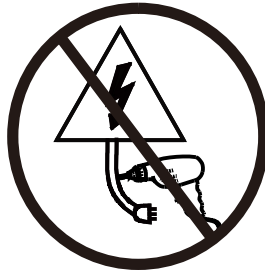
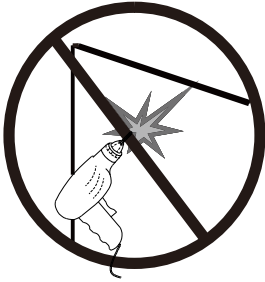
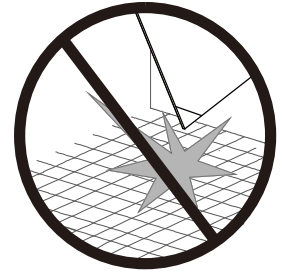

Nettoyage & Entretien

Enlevez les déchets régulièrement afin d'éviter le blocage de la fuite . En général ,vous pouvez nettoyer la paroi de douche par serpillière avec des détergents doux.

Veillez ne pas nettoyer la paroi de douche avec les détergents forts comme l'alcool ,l'essence ou autres nettoyeurs chimiques.

S'il y a des taches sur la paroi, vous pourriez la nettoyer par un calicot avec dentifrice, cependant , vous la nettoieriez à l'eau après.

Lorsque vous finissez l'installation et pivotez la porte ,s'il y a du bruit ,vous pouvez appliquer un peu lubrifiant sur des rouleaux, charnières et la glissière.